



FLAG DROP TYPE FAULT INDICATOR

ZK TYPE



STRUCTURE



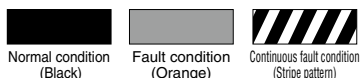

System: Flag Drop Type Fault Indicator

- Indication & Reset operation:**
- The fault signal generated by the outer protective relay contacts excites the operating coil and drop the indication flag in the annunciator. The display window of the flag changes from the normal condition of black to the fault condition of orange.
 - Pushing up the reset lever returns the indicator flag to the original position, and window returns to normal condition black, if the fault signal was momentary and operating coil is not excited any more.

Indication pattern: However if the fault signal is continuous and still excites the operating coil, indicator flag in the display window change to stripe pattern in orange and black by operating the reset lever. After the fault signal is disappear the flag automatically return to the normal condition black.



● Operation

-  →  : Manual resetting
 →  : Automatic resetting

SPECIFICATIONS (RATINGS, PERFORMANCE)

Specification	Type	Voltage operation type	Current operation type
Rated insulation voltage (UI)		250V	
Coil rating	Voltage	24V, 48V, 100 / 110V, 125V, 200 / 220V AC / DC, 240V AC	—
	Current	—	0.5A, 0.7A, 1.0A, 2.0A DC
Continuous input range		24V, 48V AC / DC: 80 to 130% Others: 70 to 130%	90 to 100% (in case of continuous input)
Operating value		Rating x 70% max.	Rating x 90% max.
Returning value		Rating x 10% or more	Rating x 10% or more
Minimum input pulse width (rated voltage or current)		30 msec max.	30 msec max. (200% input of rated current, 10 msec max.)
External Terminal		Faston #250 or screw terminal (M3.5)	
Max. wire size		2mm ² max. (AWG14)	
Insulation resistance		10MΩ or more (Between electric circuit block and ground) / 5MΩ or more (electric circuit between each other / Between contact terminals [Between poles])	
Power frequency Withstand voltage		2,000V AC (Between electric circuit block and ground / electric circuit between each other) / 1,000V AC (Between contact terminals [Between poles]) / 1 min.	
Lightning impulse withstand voltage		±4.5kV (Between electric circuit block and ground / electric circuit between each other) / ±3kV (Between contact terminals [Between poles]) / 3 times for each poles (1.2 / 50μs)	
Overload capability		Rating x 1.3 times / 3 hours / 1 time	Rating x 6.0 times / 30 sec. / 1 time
Contact current-carrying capacity		2A	
Contact breaking capacity		110V DC, 0.2A (L/R = 7msec)	
Vibration resistance		Frequency: 16.7Hz, Width of frequency: 4mm, 10 min for each axis	
Shock resistance		294m/s ² , 3 times each axial direction	
Durability		10,000 times or more (electrical, mechanical)	
Protection degree		Panel surface: IP40	
Ambient operating temperature		0 to 40°C (-10 to 55°C: a few hours are allowed per day)	
Storing temperature		-20 to 60°C	
Relative humidity		30 to 80% (average per day, no dew condensation)	
Altitude		2,000 m max.	
Weight		300g	



ZK TYPE

FEATURES

1

The panel back size is shorter than TK type by about 25%.

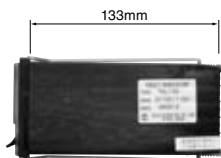

TK Type

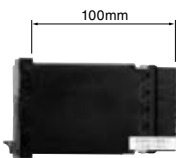

ZK Type (Faston tab type)

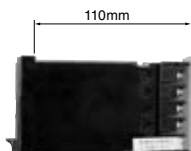

ZK Type (screw type)

2

Faston / Tab type and Screw type are available as standard line up. Screw type is equipped with a terminal cover. Vertical and horizontal jumper for link reduce wires.

3

Short time input operation is available for current type. (operating at 200% or more of rated current, at input pulse of 10 msec). It sensitively responds to an pulse input signal to the annunciator relay. For further details, refer to technical information (page B62).

4

4 cotacts can be choosed from 2 cotacts linked with the display flag and 3 cotacts linked with the coil voltage. Wide contact variations enable to omit some auxiliary relays now in use.

5

The approximately 40% expansion of the name character area enhances visibility of a nameplate.

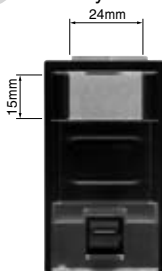

TK Type

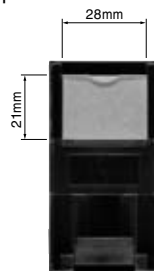

ZK Type

6

A plug-in method for internal elements is adopted, which enables easy changing of specifications and maintenance from the front of the panel.

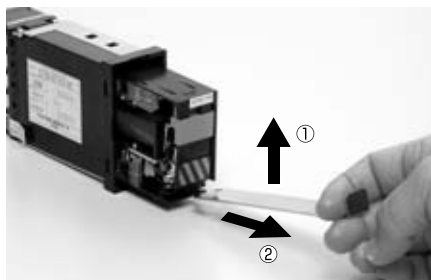

* When removing the internal element, hang an element unplugging tool on the lower hook to unplug by lifting and removing the lock.

7

Measures for whisker trouble are fully prepared by eliminating the use of tin and zinc plating.

8

Collective mounting is available, which saves hole cutting work one by one. It contributes to reduce man-hour. (A vertical one-line assembly is not available).

HOW TO ORDER

How to order as single unit

ZK - 120A - DC110V XX - OBF

Basic type

Contact arrangements

(For further details, see Page B60.)

Code	Flag interlock	Coil interlock
000A	-	-
010A	-	1a
020A	-	2a
030A	-	3a
020D	-	1a1b
100A	1a	-
110A	1a	1a
120A	1a	2a
120D	1a	1a1b
120E	1a	2b
200A	2a	-
220A	2a	2a
210A	2a	1a

Any contact arrangements other than those above are available.

Rated voltage / current

Voltage operation type		
Code	Coil rating	Resistance value
DC024V	24V DC	270Ω
DC048V	48V DC	1080Ω
DC110V	100 / 110V DC	4800Ω
DC125V	125V DC	6900Ω
DC220V	200 / 220V DC	19500Ω
AC024V	24V AC	270Ω
AC048V	48V AC	1080Ω
AC110V	100 / 110V AC	4800Ω
AC125V	125V AC	6900Ω
AC220V	200 / 220V AC	19500Ω
AC240V	240V AC	24100Ω

Note: Voltage type AC rated product has a built-in 800V rated rectifier.

Current operation type		
Code	Coil rating	Resistance value
DC0.5A	0.5A DC	4.4Ω
DC0.7A	0.7A DC	2.1Ω
DC1.0A	1.0A DC	1.0Ω
DC2.0A	2.0A DC	0.28Ω

Surface frame
B: Black

Flag color

O: Yellow-red (orange)

* When coil excitation continues after reset operation, the flag color turns pattern black and orange.

Special specification

Code	Description
XX	Standard specification
XZ	Varistor mounted type (Voltage type only)

* XZ type is special.

Rear surface terminal

Code	Description
S	Screw terminal (M3.5)
F	Faston tab #250

How to order internal elements

ZK - U - 120A - DC110VXX - O

Basic type

Internal element

Contact arrangements

(For further details, see Page B60.)

Code	Flag interlock	Coil interlock
000A	-	-
010A	-	1a
020A	-	2a
030A	-	3a
020D	-	1a1b
100A	1a	-
110A	1a	1a
120A	1a	2a
120D	1a	1a1b
120E	1a	2b
200A	2a	-
220A	2a	2a
210A	2a	1a

Any contact arrangements other than those above are available.

Rated voltage / current

Voltage operation type		
Code	Coil rating	Resistance value
DC024V	24V DC	270Ω
DC048V	48V DC	1080Ω
DC110V	100 / 110V DC	4800Ω
DC125V	125V DC	6900Ω
DC220V	200 / 220V DC	19500Ω
AC024V	24V AC	270Ω
AC048V	48V AC	1080Ω
AC110V	100 / 110V AC	4800Ω
AC125V	125V AC	6900Ω
AC220V	200 / 220V AC	19500Ω
AC240V	240V AC	24100Ω

Note: Voltage type AC rated product has a built-in 800V rated rectifier.

Current operation type		
Code	Coil rating	Resistance value
DC0.5A	0.5A DC	4.4Ω
DC0.7A	0.7A DC	2.1Ω
DC1.0A	1.0A DC	1.0Ω
DC2.0A	2.0A DC	0.28Ω

Flag color

O: Yellow-red (orange)

* When coil excitation continues after reset operation, the flag color turns pattern black and orange.

Special specification

Code	Description
XX	Standard specification
XZ	Varistor mounted type

* XZ type is special.

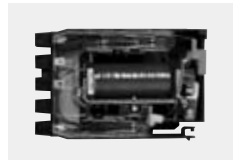

● Internal element



ZK TYPE

How to order as assembled products

- Collective mounting is available for ZK type. It is not necessary to make holes for each units, and the assembled units can be installed in only one hole.

1 In case of assembling the same specification

ZK - 02 x 03 - 120A - DC110VXX - OBF

Basic type Vertical number Horizontal number Contact arrangement Rated voltage, Current

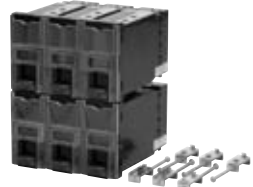

2 In case of assembling different specifications

Please enter the order sheet for ZK Drop Type Annunciator Relay attached to the page B63.

ZK - 02 x 03 - MIX - MIX - OBF

Basic type Vertical number 1 to 3 stages Horizontal number 2 to 8 stages Contact arrangement Rated voltage, Current

① Please refer to the above type coding for orders.

- Please write "MIX" in "Contact arrangement" in case of assembling different specifications of contact arrangement.
- Please write "MIX" in "Rated voltage, current" in case of assembling different specifications of rated voltage, current

② About the layout drawing

- Enclose the shape of the assembled window in the layout drawing with a continuous line.

③ About the layout configuration

- Fill the contact arrangement, rated voltage and current, and rear terminal in the layout configuration.

Order Sheet for ZK Type Fault Indicator

Date of order: (month) (day), (year)

Company name		Person in charge	
Address		TEL	
Type of order		FAX	
Quantity	Units	Delivery time (month) (day), (year)	Number of Order

● Please enclose the following layout drawing with a continuous line as the shape of an assembled window.
 ● Please fill the contact arrangement, rated voltage, current, special specification and also rear terminal in the following layout configuration.
 ● The sizes of the mounting hole are the horizontal outside dimension: 4 mm and the vertical outside dimension: 5 mm.

Layout drawing

	1	2	3	4	5	6	7	8
A	A-01	A-02	A-03	A-04	A-05	A-06	A-07	A-08
B	B-01	B-02	B-03	B-04	B-05	B-06	B-07	B-08
C	C-01	C-02	C-03	C-04	C-05	C-06	C-07	C-08

Layout configuration

	Contact arrangement	Rated voltage (V)	Special specification	Rear surface terminal
A-01	ZK - 120A	DC 110V	XX	OBF
A-02	ZK - 110A	DC 110V	XX	OBF
A-03	ZK - 110A	DC 110V	XX	OBF
A-04	ZK -			OB
A-05	ZK -			OB
A-06	ZK -			OB
A-07	ZK -			OB
A-08	ZK -			OB
B-01	ZK - 110A	DC 110V	XX	OBF
B-02	ZK - 110A	DC 110V	XX	OBF
B-03	ZK -			OB
B-04	ZK -			OB
B-05	ZK -			OB
B-06	ZK -			OB
B-07	ZK -			OB
B-08	ZK -			OB
C-01	ZK -			OB
C-02	ZK -			OB
C-03	ZK -			OB
C-04	ZK -			OB
C-05	ZK -			OB
C-06	ZK -			OB
C-07	ZK -			OB
C-08	ZK -			OB

* Precaution for assemblies

When ordering a collective type of rear terminal symbols S (screw specification), please order after taking the wire size and number of wires into account (there is a possibility that wiring may be difficult depending on the wire size and number of wires).

Sizes of collective mounting

Refer to the right table as to sizes of collective mounting when mounting collectively.

A virtual one-line assembly is not available.

Table of sizes

		Horizontal stage number						(mm)	
		2 row	3 row	4 row	5 row	6 row	7 row		8 row
Vertical stage number	First stage	L1	72	108	144	180	216	252	288
		L2	70						
		L3	81						
	Second stage	L1	72	108	144	180	216	252	288
		L2	140						
		L3	151						
	Third stage	L1	72	108	144	180	216	252	288
		L2	210						
		L3	221						

* Single row is not available.

STANDARD PRODUCTS

ZK (Faston type)

● Outline

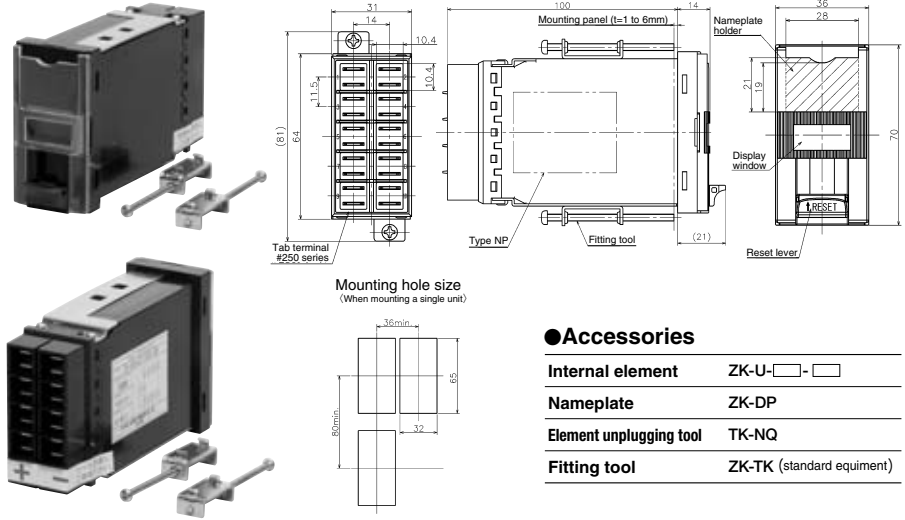

ZK (Faston type [collective])

● Outline

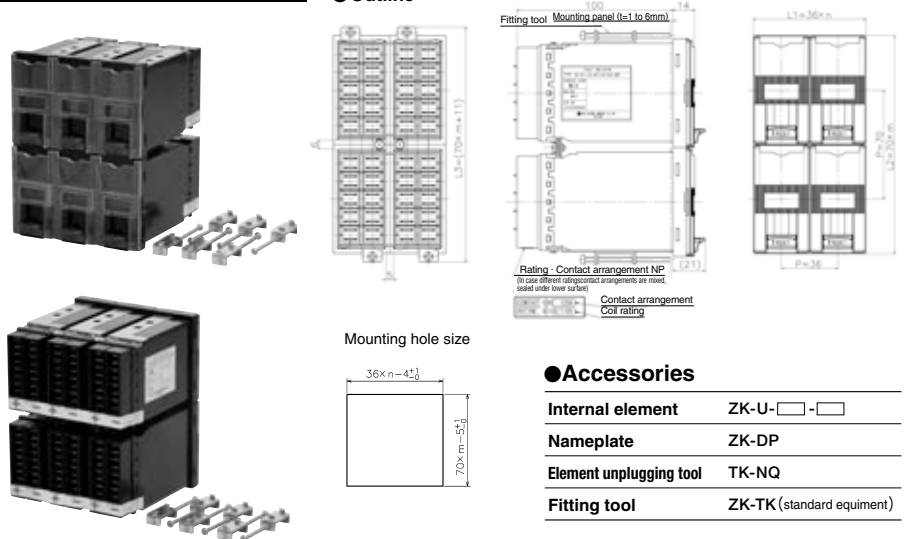



FLAG DROP TYPE FAULT INDICATOR

ZK TYPE

STANDARD PRODUCTS

ZK (Screw type)

● Outline

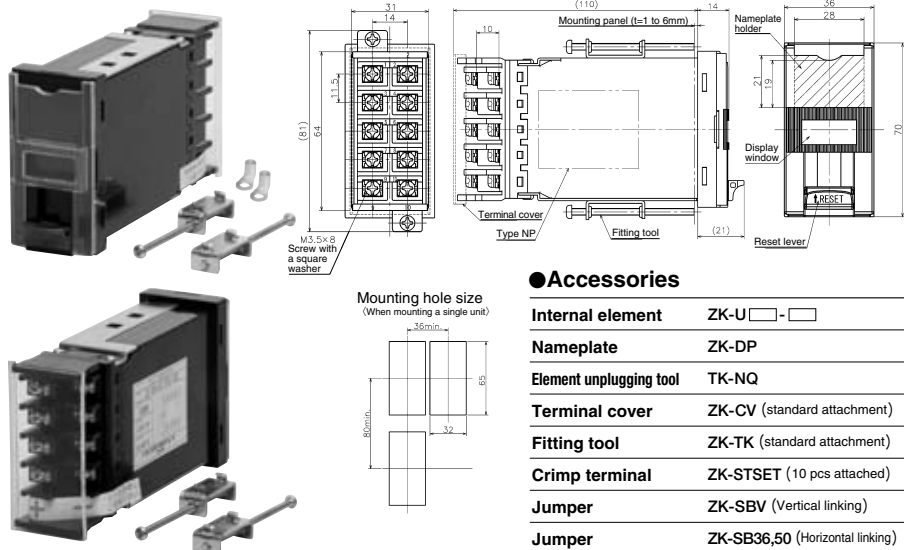

● Accessories

Internal element	ZK-U □ - □
Nameplate	ZK-DP
Element unplugging tool	TK-NQ
Terminal cover	ZK-CV (standard attachment)
Fitting tool	ZK-TK (standard attachment)
Crimp terminal	ZK-STSET (10 pcs attached)
Jumper	ZK-SBV (Vertical linking)
Jumper	ZK-SB36,50 (Horizontal linking)

ZK (Screw type [collective])

● Outline

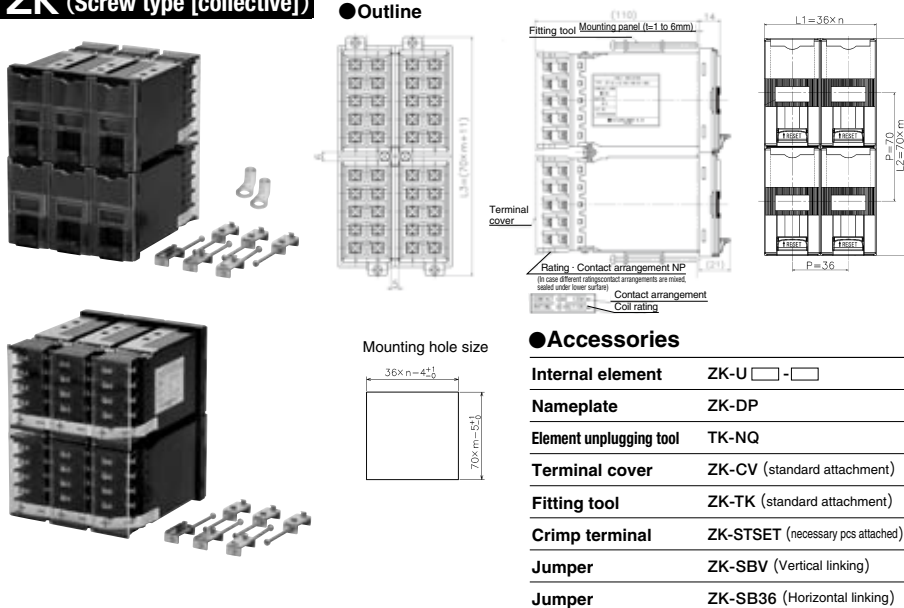

● Accessories

Internal element	ZK-U □ - □
Nameplate	ZK-DP
Element unplugging tool	TK-NQ
Terminal cover	ZK-CV (standard attachment)
Fitting tool	ZK-TK (standard attachment)
Crimp terminal	ZK-STSET (necessary pcs attached)
Jumper	ZK-SBV (Vertical linking)
Jumper	ZK-SB36 (Horizontal linking)

CONTACT ARRANGEMENTS AND SEQUENCES

About contact arrangement

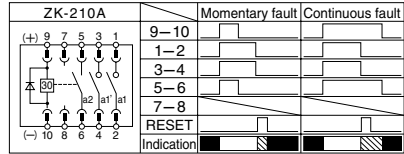
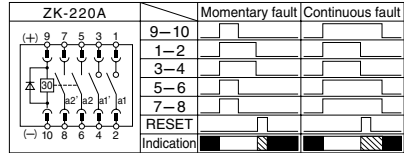
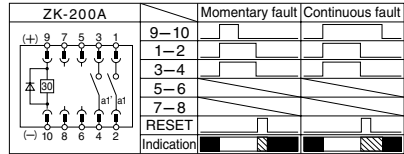
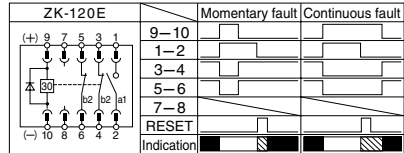
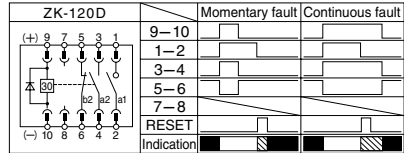
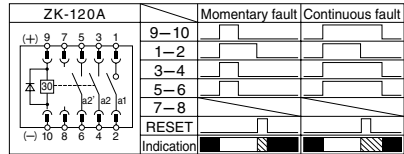
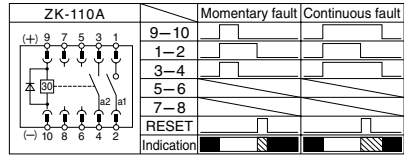
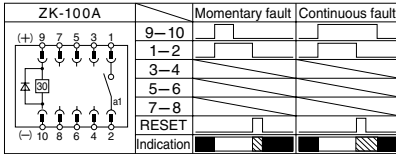
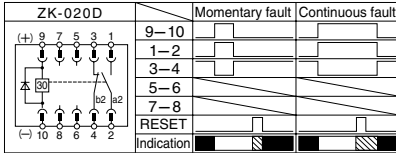
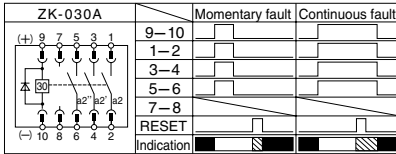
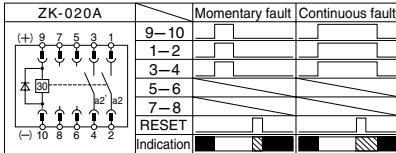
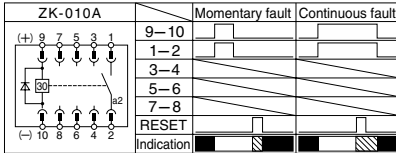
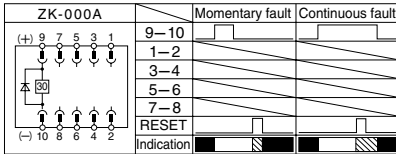
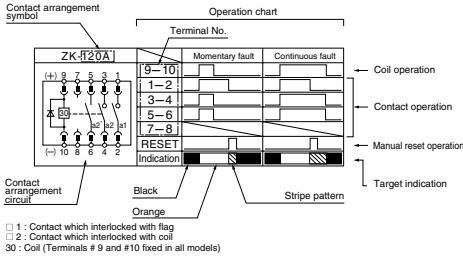

* Any contact arrangements other than those above are available. Please feel free to inquire.



ZK TYPE

ACCESSORIES

Element unplugging tool

●TK-NQ

(Order unit: 10)



Fitting tool

(Order unit: 10)

●ZK-TK



* Standard equipment

Jumper

(Order unit: 100)

* For rear terminal symbol S (screw specification)

ZK-SBV	ZK-SB36	ZK-SB50
Vertical linking	Horizontal linking (36mm pitch)	Horizontal linking (50mm pitch)
For vertical adjacent terminals	For upper stage terminals of min. pitch instration (36mm) or assembled type	For upper stage terminals of 50mm pitch instration

Terminal cover

(Order unit: 100)

* For rear terminal symbol S (screw specification)

●ZK-CV

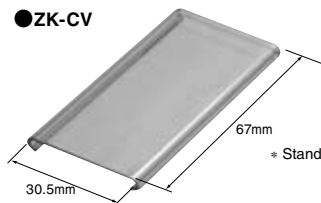

* Standard equipment

Nameplate

(Order unit: 100)

(Acryl material t = 1mm)

●ZK-DP

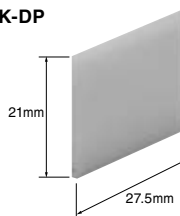

* Commercial cardboards are also available instead of ZK-DP.

Cramp terminal

(Order unit: 100)

●ZK-ST



* Standard accessory for screw type (10 pcs).

TECHNICAL DATA

■ Operating condition of current type

For the current operation type, it is sometimes used by connecting in series with a relay equipped with a self-cutoff contact in the manner shown in Figure 1; in that case, current I shows the waveform shown in Figure 2 depending on the coil inductance of those serial relays.

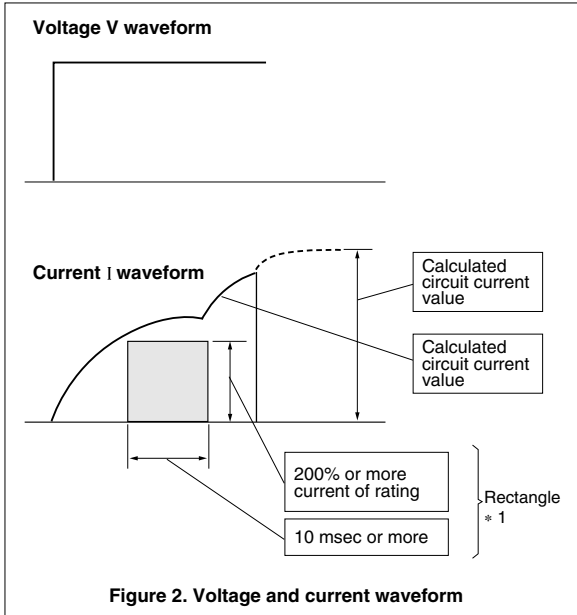
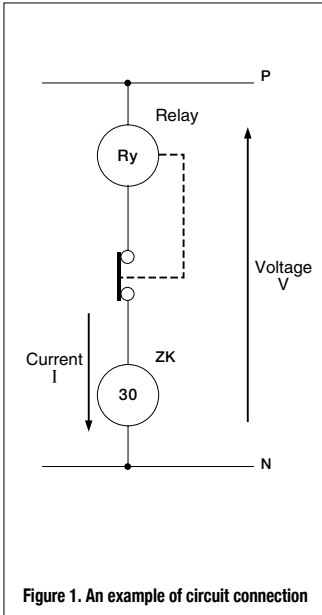

When high-speed operation is required (operation at 200% or more of rated current and minimum input pulse of 10 msec or less), please select a coil rating that can secure a rectangle*1 within the actual circuit current waveform

High-speed operation is confirmed in the condition with the resistance value of the serial relay (Fig. 1 Ry) in the following table.

Coil rating of Fault Indicator	Relay resistance value
0.5A DC	36.7Ω
0.7A DC	26.2Ω
1A DC	18.3Ω
2A DC	9.2Ω



ZK TYPE

Order Sheet for ZK Type Fault Indicator

Date of order: (month) (day), (year)

Company name				Person in charge	
e-mail				TEL	
Type coding				FAX	
Quantity	Units	Delivery time	(month) (day), (year)	Number of Order	

- Please enclose the following layout drawing with a continuous line as the shape of an assembled window.
- Please fill the contact arrangement, rated voltage, current, special use and also rear terminal in the following layout configuration.
- The sizes of the mounting hole are the horizontal outside dimension: -4 mm and the vertical outside dimension: -5 mm.

Layout drawing

	1	2	3	4	5	6	7	8
A	A-01	A-02	A-03	A-04	A-05	A-06	A-07	A-08
B	B-01	B-02	B-03	B-04	B-05	B-06	B-07	B-08
C	C-01	C-02	C-03	C-04	C-05	C-06	C-07	C-08

Layout configuration

		Contact arrangement	Rated voltage, current	Special specification	Rear surface terminal
Row A	A-01	Z K —	—	—	—OB
	A-02	Z K —	—	—	—OB
	A-03	Z K —	—	—	—OB
	A-04	Z K —	—	—	—OB
	A-05	Z K —	—	—	—OB
	A-06	Z K —	—	—	—OB
	A-07	Z K —	—	—	—OB
	A-08	Z K —	—	—	—OB

		Contact arrangement	Rated voltage, current	Special specification	Rear surface terminal
Row B	B-01	Z K —	—	—	—OB
	B-02	Z K —	—	—	—OB
	B-03	Z K —	—	—	—OB
	B-04	Z K —	—	—	—OB
	B-05	Z K —	—	—	—OB
	B-06	Z K —	—	—	—OB
	B-07	Z K —	—	—	—OB
	B-08	Z K —	—	—	—OB

		Contact arrangement	Rated voltage, current	Special specification	Rear surface terminal
Row C	C-01	Z K —	—	—	—OB
	C-02	Z K —	—	—	—OB
	C-03	Z K —	—	—	—OB
	C-04	Z K —	—	—	—OB
	C-05	Z K —	—	—	—OB
	C-06	Z K —	—	—	—OB
	C-07	Z K —	—	—	—OB
	C-08	Z K —	—	—	—OB